

cocomakey

Microcontroller

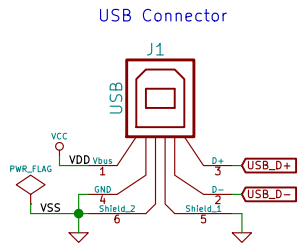

(USB Cable Pads)

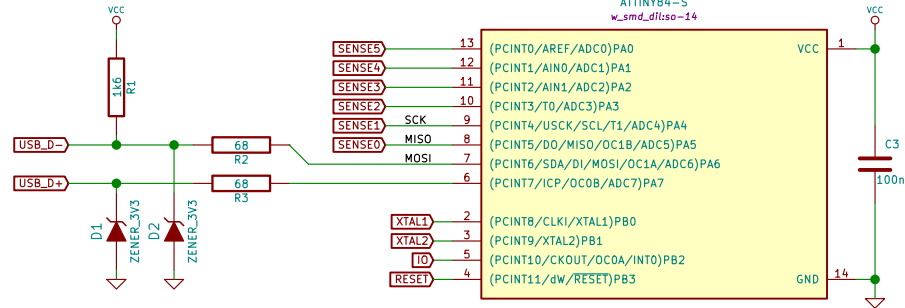
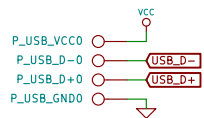

Crystal

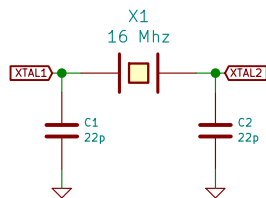

Touch Pad Connector

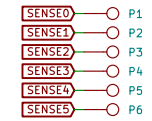

ISP Pads

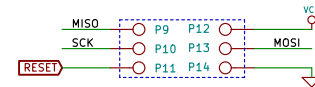

(Additional Pins)

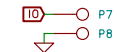

Sheet: /	
File: cocomakey.sch	
Title: cocomakey	
Size: A4	Date: 2015-12-28
KiCad E.D.A. kicad (2015-12-18 BZR 6383)-stable	Rev: 0.01
	Id: 1/1